

VELJAN model V4D06 pilot operated Directional Control valves conform to NFPA D08, CETOP 08 standard interface. These are subplate and manifold mounted and can be used in conjunction with stack valve system. The valve mounting interface and electrical connection methods conform to international standards CETOP,ISO, DIN. The coils used in the wet pin design solenoids are available in A.C. and D.C. voltages and are continuously rated. Precise guide for all types of spools is achieved by uniquely designed eight annuli body. Spools are interchangeable and no selective assembly is necessary. Streamlined internal channels ensure minimum pressure drop at maximum flow.

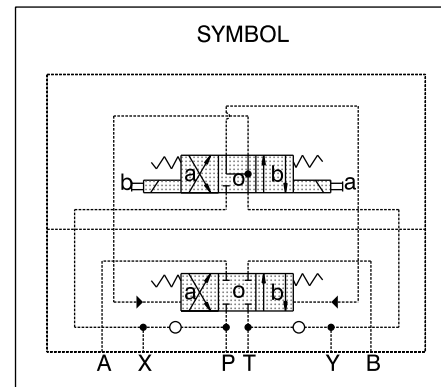

Features

- ◆ Extremely low pressure drop-energy saving.
- ◆ High functional limit up to 185 gpm(700l/min) at nominal pressure.
- ◆ Mounting configuration according to CETOP, ISO 4401.
- ◆ Nominal operating pressure 350bar (5000psi).
- ◆ Interchangeability of spools & bodies due to high precision manufacturing processes.
- ◆ Actuated by electrical / hydraulic or lever mechanism.
- ◆ Wide range of A.C. and D.C. coil voltages are available both with or without manual override.
- ◆ Wide variety of spools available.
- ◆ Change of solenoid coil is fast and simple without risk of oil leakage.
- ◆ Permissible pressure in the tank port up to 350bar (5000psi) with external drain, up to 210 bar (3000psi) with internal drain (see characteristics).
- ◆ Every valve is factory tested prior to despatch.

Operation

The electrically operated 4-way valve V4D06 consists of a main body and a solenoid operated pilot valve. The energized solenoid shifts the pilot control spool, thus directing fluid to one end of the main spool, and moving it to the desired position. Fluid can then flow from port P to either port A or B whilst the alternate port (B or A) is connected to the tank line. The necessary pilot pressure can be obtained internally from the system port P or from an external pressure supply connected to port X.

De-energizing the solenoid allows both the pilot control and the main spool to return to their neutral positions. The hydraulically operated version may be remotely controlled by an external pilot valve. The main spool of the direct operated valves can be moved mechanically by means of a lever.

Pilot Valve with Wiring Box

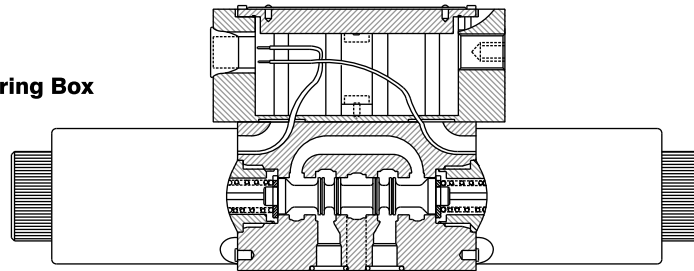

Pilot Valve with 3 Pin Socket

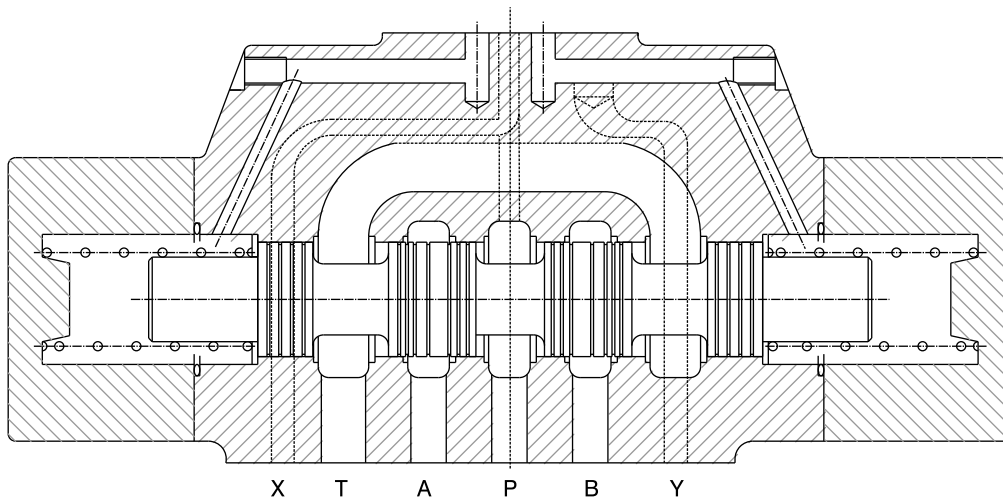
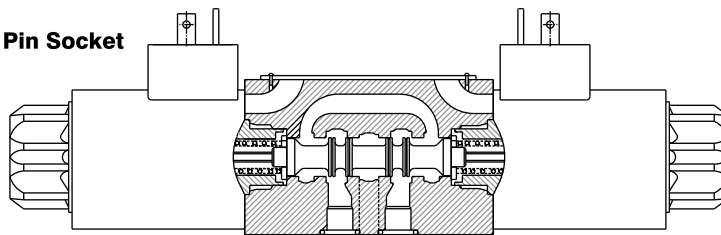

Orifice

In certain operating conditions, a flow greater than the functional limit of the pilot valve may be generated. It is recommended that one orifice be fitted in the P port of the pilot valve (code 10 for solenoid operation) or two orifices in the A & B ports of the pilot cap (code P3 for hydraulic operation).

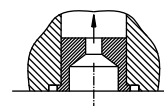

PILOT VALVE ORIFICE

Characteristics

Design	Sliding spool valve
Type of Mounting	Subplate conform to NFPA D08, CETOP 08, ISO 4401.
Mounting Position	Optional (Horizontal recommended)
Ambient temperature range	0....120°F (-18+50°C)
Operating Pressure(P,A,B,X)	350 bar (5000 psi) max.
Operating Pressure(T,Y)	see below and page 13
External pilot pressure at 185gpm (700l/min)	
-min	9bar (130psi) for spools with open center position 10 bar(145psi) for spools with closed center position.
-max	350bar(5000psi) > 250 bar...350bar(3625psi.....5000psi) a pilot orifice dia. 1,0 mm in P-port is recommended (code 10 or P3).
Max. flow	185gpm (700l/min) (see diagram - Pressure drop curves)
Max.leakage	21....55in ³ /min (350...900ml/min) (depends on spool type)
Fluid	Petroleum base anti-wear fluids. Such as mineral oil according to DIN 51524/25. Maximum catalogue ratings and performance data are based on operation with these fluids.
Viscosity range	10....650 cSt optimum 30 cSt
Fluid temperature range	0....176°F(-18....+80°C)
Contamination level	Max. permissible contamination level according to NAS 1638 Class 8 (Class 9 for 15 Micron and smaller) or ISO 17/14.

Solenoid Characteristics

	A.C.	D.C.
Voltage	see ordering code	see ordering code
Power Input	20 W	29 W
Holding Power	45 VA	
Inrush Power	198 VA	
Permissible Tank Pressure (T) :		
- With internal drain	140 bar (2000 psi)	210 bar (3000 psi)
- With external drain	350 bar (5000 psi)	350 bar (5000 psi)
Permissible drain Pressure (Y) :	140 bar (2000 psi)	210 bar (3000 psi)
Permissible Voltage difference	± 10%	± 10%
Maximum coil temperature	135°C (275° F)	105 °C (220° F)
Relative Operating Period	100%	100%
Type of Protection	IP 65	IP 65
Insulation Class	H	F
Cycle (1/H)	14400	14400

	V4D06	-	3	*	**	-	**	**	-	*	*	A	*	***	-	10	**	**
	1			2	3		4	5		6	7	8	9	10		11	12	13
1 Series	06 = Cetop 8																	
2 Control	A = Pilot operated, 1 solenoid (V4D01) B = Pilot operated, 2 solenoids (V4D01) C = Pilot operated, 2 solenoids (V4D01) pilot valve; 2 pos. detents O = Hydraulic operation																	
3 Spool type	Refer to pages 6, 7 & 8																	
4 Spool Position	01 = 2 (a,b), spring offset to pos. "b", energized to "a" 02 = 2 (a,b), Spring offset to pos. "a", energized to "b". 03 = 3 (a,o,b), Spring centered pos. "o" 04 = 2 (a,b), Spool is not centered, energized to "a" or "b" (pilot valve with detents). 05 = 2 (o,b), spring centered pos. "o", energized to "b". 06 = 2 (o,a), Spring centered pos. "o", energized to "a".																	
5 End Cap	03 = for controls A, B, C, O. 09 = for controls A, B, C, O with adjust. spool stop on both sides.																	
6 Pilot Connection	0 = External PP, external PD (for hydraulic operation). 1 = Internal PP, Internal PD ¹⁾ 2 = Internal PP, external PD ¹⁾ 3 = External PP, internal PD 4 = External PP, external PD																	
7 Main Valve Accessories	0 = without 4 = Integral check in "P" ¹⁾																	
8 Design Letter																		
9 Seal Class	1 = NBR-seals (Standard) 4 = EPDM-seals 5 = FPM-seals (Viton)																	
10 Solenoid Voltage	W01 = 115V / 60Hz W02 = 230V / 60Hz W06 = 115V / 50Hz W07 = 230V / 50Hz	AC	GOR = 12 V GOQ = 24 V	DC														
Order information for plug-in connectors see page 11																		
1* Pilot Accessories and modifications	10 = 1,0mm orifice in P-port; for solenoid with manual override. 1028 = 1,0 mm orifice in P-port; wiring box with 6" flying leads. 1032 = 1,0 mm orifice in P-port; for solenoid without manual override 1052 = 1,0 mm orifice in P-port; for solenoid with manual override; with rubber cover. 102852 = 1,0mm orifice in P-port; wiring box with 6" flying leads & rubber cover. 1081 = 1,0 mm orifice in P-port; wiring box with 6" flying leads & terminal strips. 108152 = 1,0 mm orifice in P-port; wiring box with 6" flying leads & terminal strips & rubber cover. P3 = 1,0 mm orifices in A & B-ports of the cap; for hydraulic operation only (control code 0).																	

Notes:

- 1) For valves with spools 01, 07, 11, and internal PP an integral check is recommended in P-port of the main body to obtain the minimum pilot pressure. U The integral check is not provided for load pressure holding back to P-port.
- 2) For standard applications orifice in P-port always recommended.

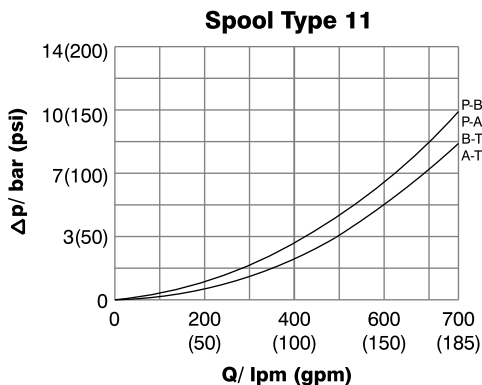
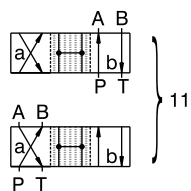
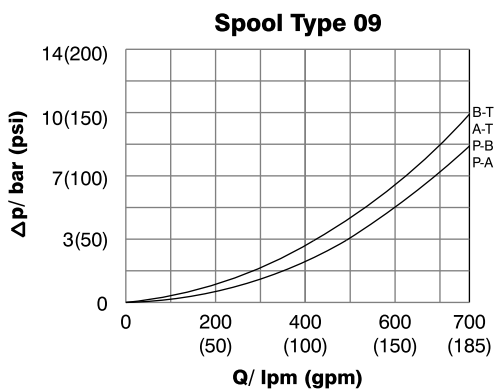
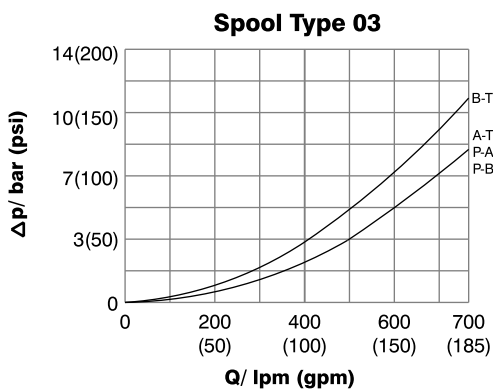
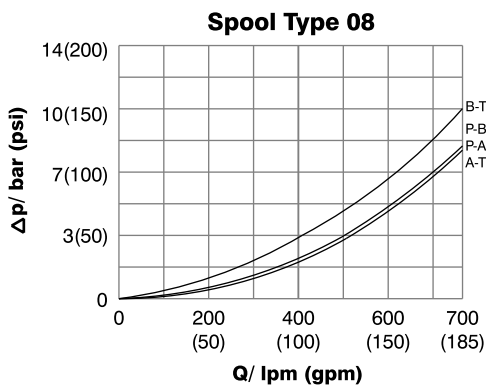
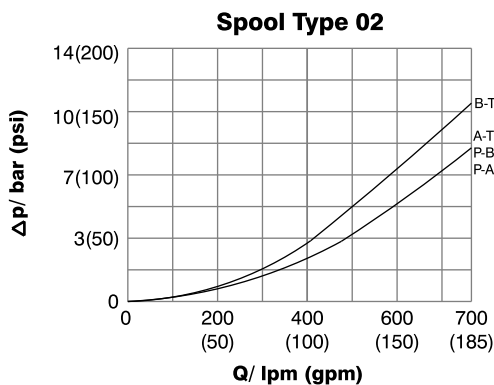
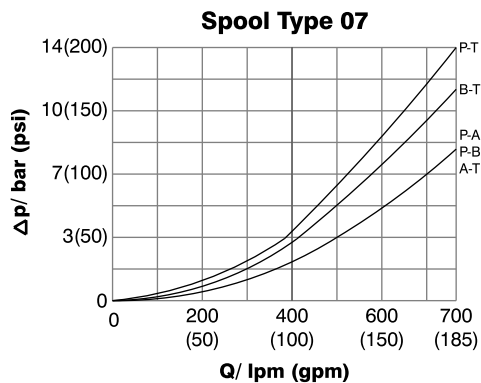
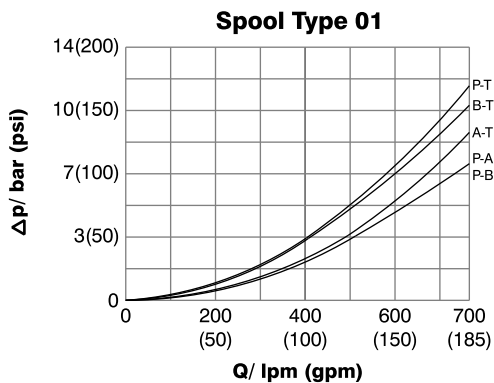
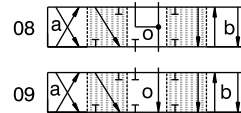
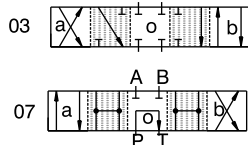
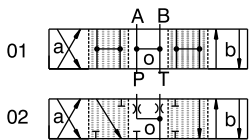

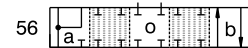
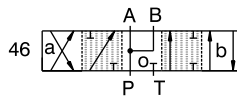
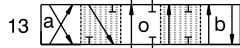
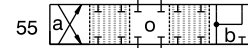
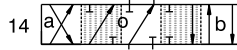
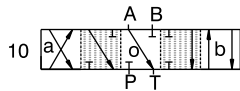

Spool Type 10

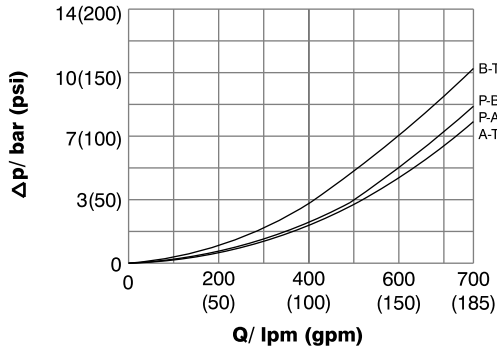

Spool Type 46

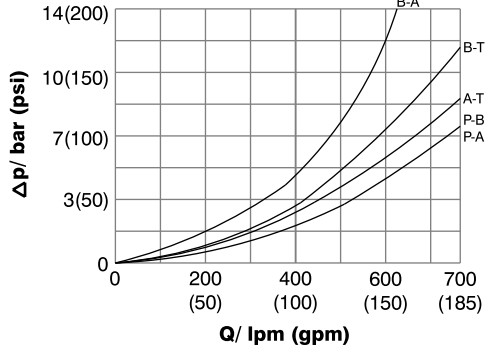

Spool Type 13

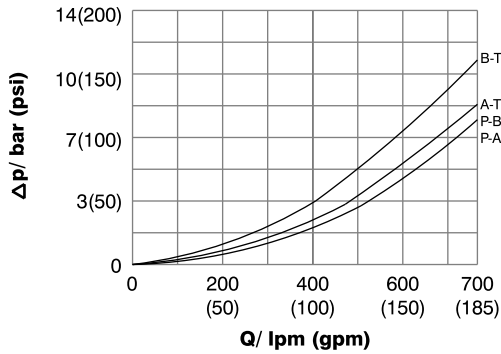

Spool Type 55

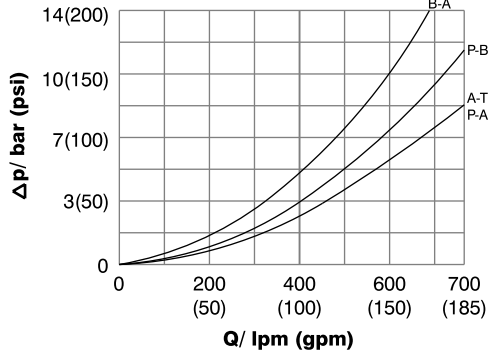

Spool Type 14

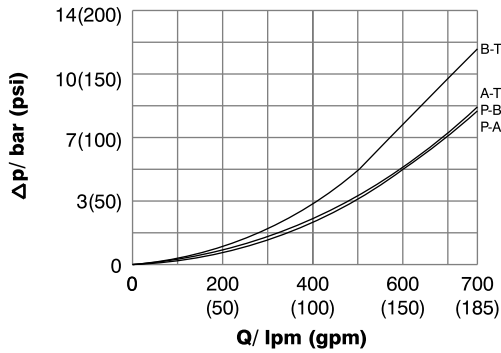

Spool Type 56

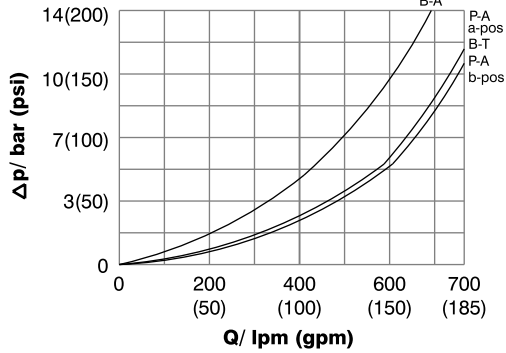

Spool Type 51

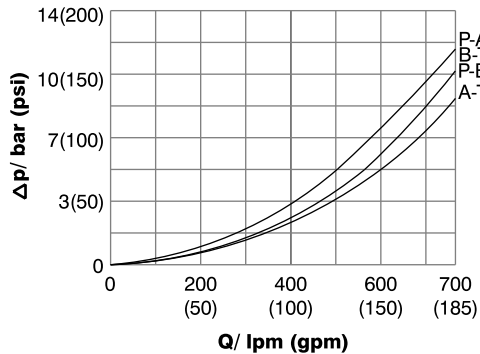
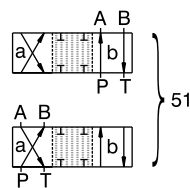

Spool Position 06

Spring Centering

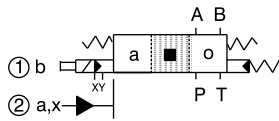

- 01
- 02
- 03
- 07
- 08
- 09
- 10
- 13
- 14
- 46
- 55
- 56

Spool Position 01

Spring Offset

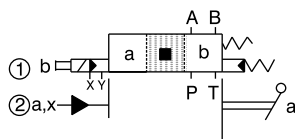

- 11
- 51

Spool Position 03

Spring Centering

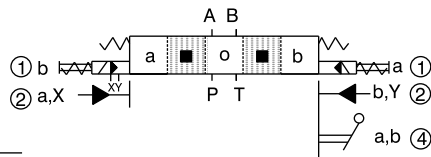

Spool Position 04

Pilot valve with Detents

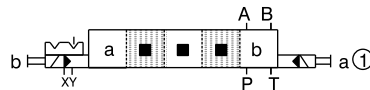

Spool Position 07

3 pos. detents

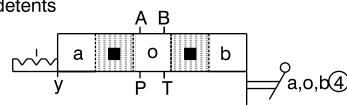

- 01
- 02
- 03
- 07
- 08
- 09
- 10
- 13
- 14
- 46
- 55
- 56

Spool Position 05

Spring Centering

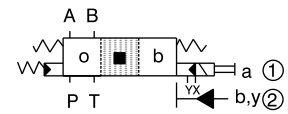

- 01
- 02
- 03
- 07
- 08
- 09
- 10
- 13
- 14
- 46
- 55
- 56

Spool Position 02

Spring Offset

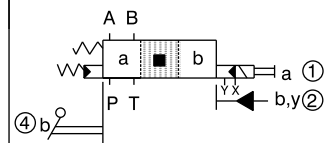

- 11
- 51

- ① Solenoid operation
- ② Hydraulic operation
- ④ Lever operation

- Standard Spool
- Transfer position only.

FUNCTIONAL LIMITS (GPM)

Spool type	max. Flow (gpm) versus Pressure (psi)				
	1000	2000	3000	4000	5000
02, 03, 08, 09, 10, 13, 14, 46, 55, 56	185	185	185	185	185
01	185	185	185	180	158
07	185	177	156	135	114
11	185	185	185/166 *	185/136 *	185/106 *
51	185	185/164 *	185/127 *	185/90 *	185/53 *

FUNCTIONAL LIMITS (LPM)

Spool type	max. Flow (lpm) versus Pressure (bar)				
	70	140	210	280	350
02, 03, 08, 09, 10, 13, 14, 46, 55, 56	700	700	700	700	700
01	700	700	700	680	600
07	700	670	590	510	430
11	700	700	700/630 *	700/515 *	700/400 *
51	700	700/620 *	700/480 *	700/340 *	700/200 *

* The "fail safe" flow limits of the spool types 11 & 51 must be reduced at higher operating pressure to comply with "safety regulations" where applicable.

Means: The main spool returns to "spring offset" position only by spring force (without pilot pressure).

V4D06 3 A51 0103 40A. ..

Spool position 01
2 (a,b), Spring Offset

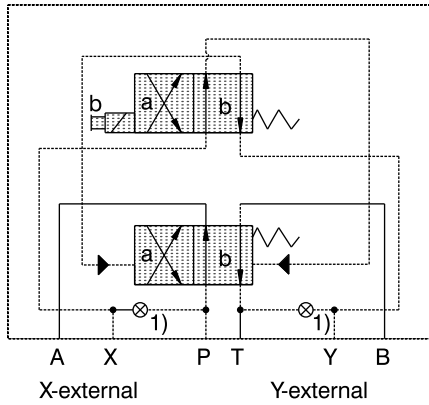

V4D06 3 A51 0203 40A. ..

Spool position 02
2 (a,b), Spring Offset

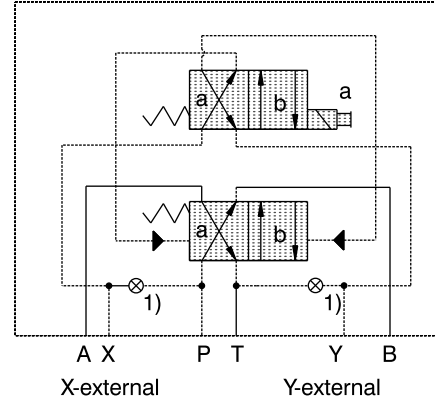

V4D06 3 B.. 0303 40A. ..

Spool position 03
3 (a,o,b), Spring Centering

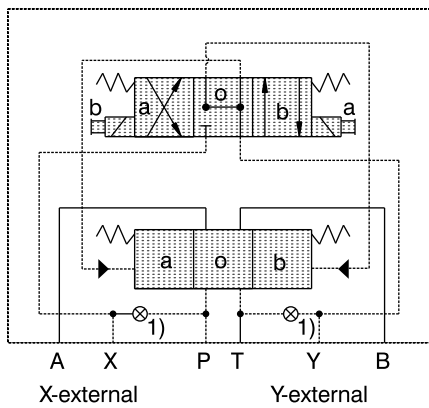

V4D06 3 C.. 0403 40A. ..

Spool position 04
2 (a,b), Pilot Valve with detents

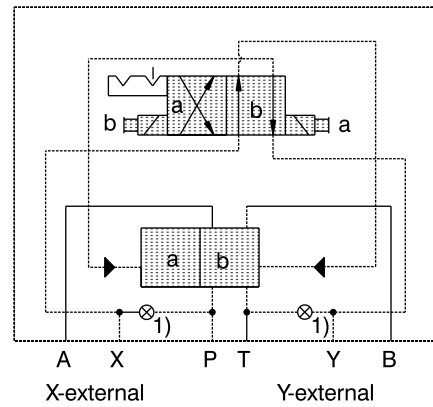

V4D06 3 A.. 0503 40A. ..

Spool position 05
2 (o,b), Spring Centering

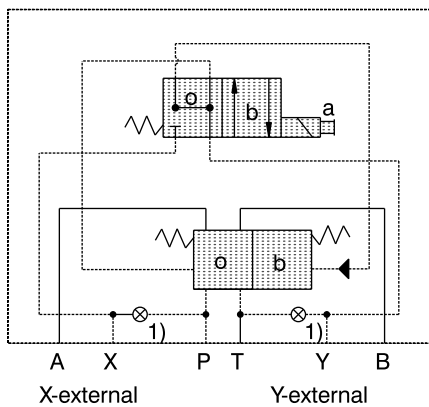

V4D06 3 A.. 0603 40A. ..

Spool position 06
2 (o,a), Spring Centering

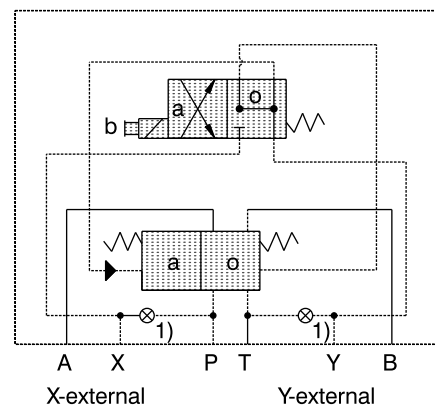

1) Plug mounted according to desired internal or external PP or PD.

1- AND 2-SOLENOID AC/DC OPERATED VERSIONS, 3 PIN SOCKET



	Weight			
	Single solenoid		Double solenoid	
	lbs	Kg	lbs	Kg
AC	37,3	16,9	38,1	17,3
DC	37,9	17,2	38,8	17,6

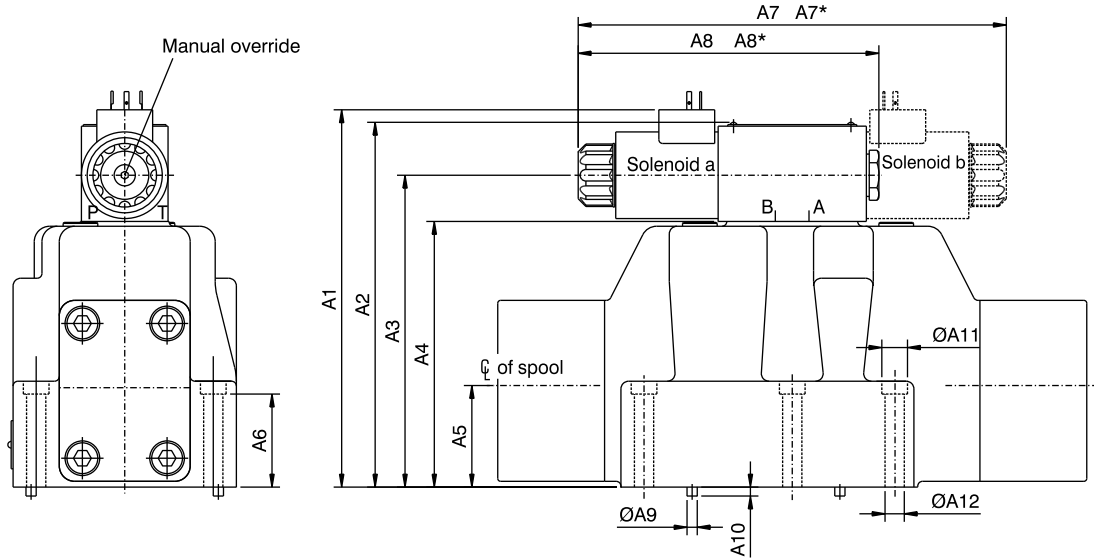

Dimension	Dimension	
	inch	mm
A1	7.32	186
A2	7.00	178
A3	5.98	152
A4	5.04	128
A5	1.77	45
A6	1.73	44
A7	8.82	224
A7*	10.39	264
A8	6.14	156
A8*	6.93	176
ØA9	0.25	6.4
A10	0.26	6.5
ØA11	0.79	20
ØA12	0.55	14

Dimension	Dimension	
	inch	mm
B1	6.07	154.2
B2	5.13	130.2
B3	2.09	53.2
B4	4.57	116
B5	3.63	92.1
B6	2.68	68
B7	2.99	76
B8	3.03	77
B9	12.05	306

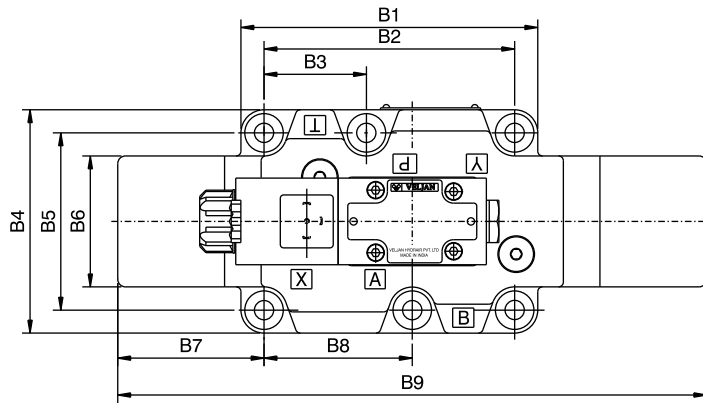

Plug-in connectors according to ISO 4400

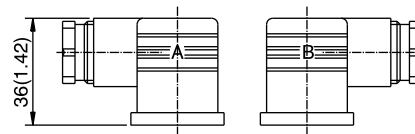

* these dimensions are for version with rubber cover

Port Functions:

P	Pressure
T	Tank
A+B	User
X, Y	Pilot & Drain ports

Versions	ISO 4400	A-side	B-side
Standard <250V	Pg11	V 167-01007-8	V 167-01008-8
with LED (red) 15 ...30V		V 167-01100-8	V 167-01101-8
with bridge rectifier 12...250V		V 167-01076-8	V 167-01014-8

Note: Plug-in connectors to be ordered as separate items.

1- AND 2-SOLENOID AC/DC OPERATED VERSIONS, WIRING BOX



	Weight			
	Single solenoid		Double solenoid	
	lbs	Kg	lbs	Kg
AC	37,3	16,9	38,1	17,3
DC	37,9	17,2	38,8	17,6

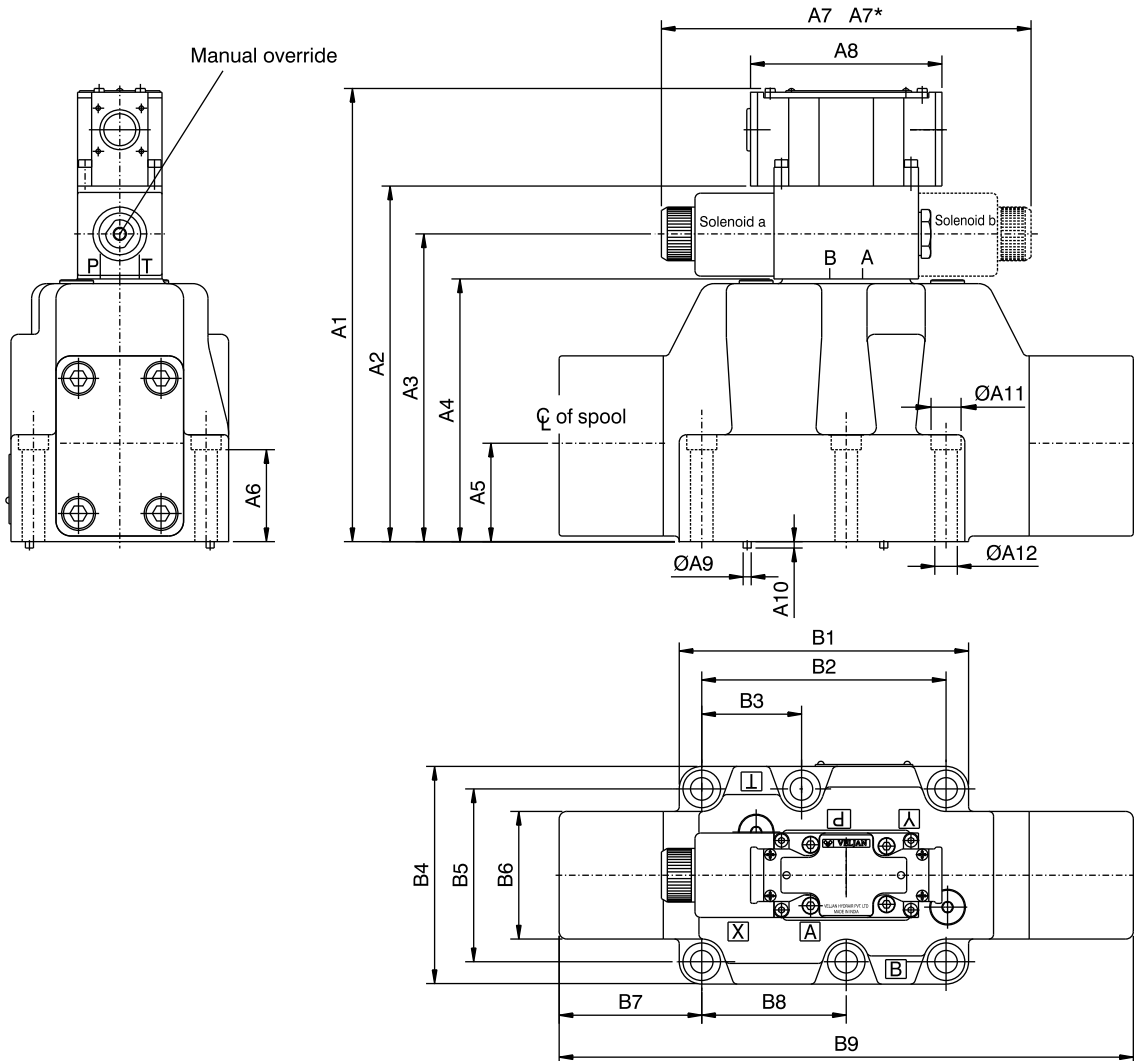

Dimension	Dimension	
	inch	mm
A1	9.06	230
A2	6.92	176
A3	5.98	152
A4	5.04	128
A5	1.77	45
A6	1.73	44
A7	8.81	224
A7*	10.39	264
A8	4.02	102
ØA9	0.25	6.4
A10	0.26	6.5
ØA11	0.79	20
ØA12	0.55	14

Dimension	Dimension	
	inch	mm
B1	6.07	154.2
B2	5.13	130.2
B3	2.09	53.2
B4	4.57	116
B5	3.63	92.1
B6	2.68	68
B7	2.99	76
B8	3.03	77
B9	12.05	306

Port Functions:

P	Pressure
T	Tank
A+B	User
X, Y	Pilot & Drain ports

* This dimension is for version with rubber cover

Permissible pressure (ports T, X, Y)350 bar (5000psi)
Weight	16.3 kg (36 lbs)

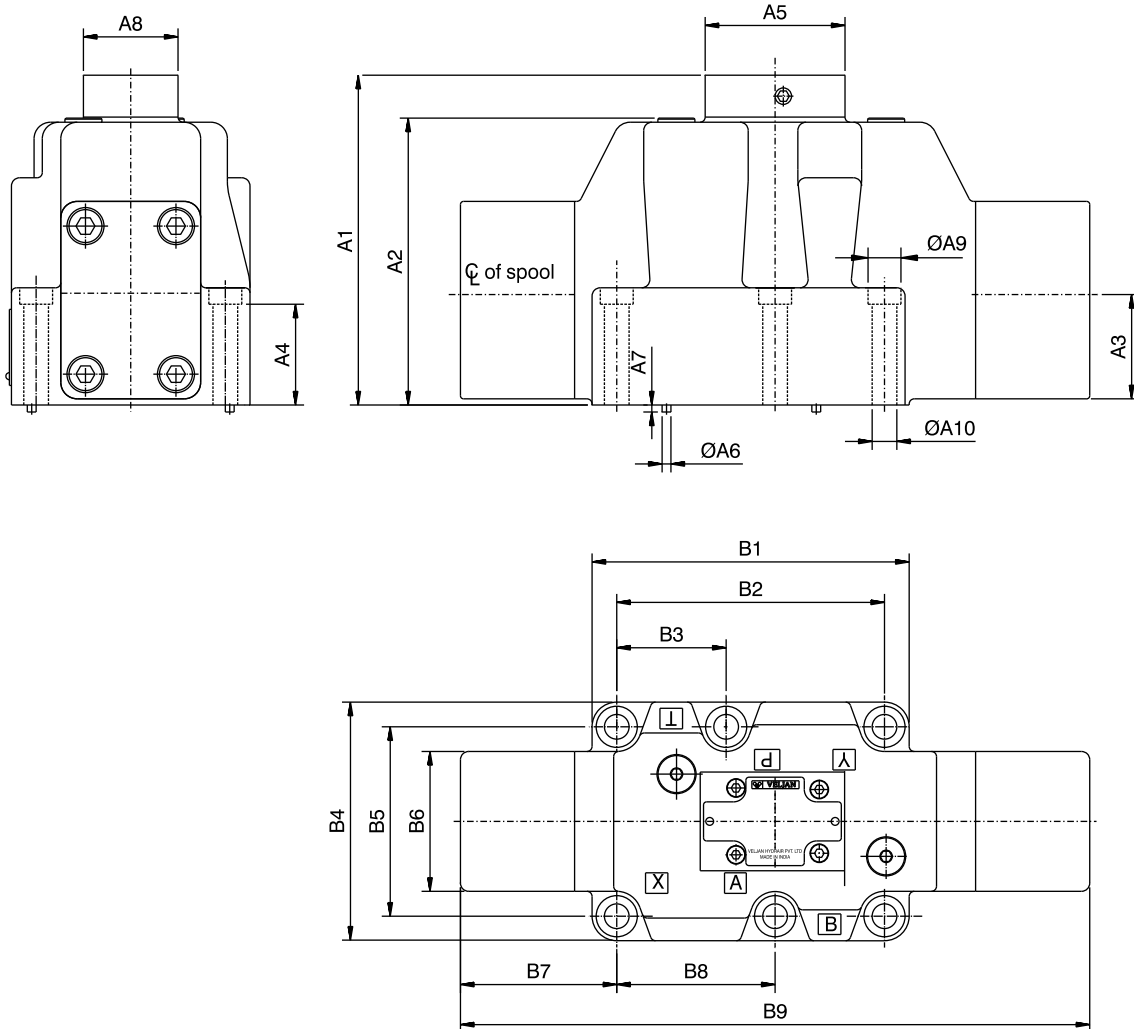

Port Functions:

P	Pressure
T	Tank
A+B	User
X, Y	Pilot & Drain ports

Dimension	Dimension	
	inch	mm
A1	5.83	148
A2	5.04	128
A3	1.77	45
A4	1.73	44
A5	2.68	68
ØA6	0.25	6.4
A7	0.26	6.5
A8	1.89	48
ØA9	0.79	20
ØA10	0.55	14

Dimension	Dimension	
	inch	mm
B1	6.07	154.2
B2	0.79	130.2
B3	2.09	53.2
B4	4.57	116
B5	3.63	92.1
B6	2.68	68
B7	2.99	76
B8	3.03	77
B9	12.05	306

Max. tank pressure	10 bar(143 psi)
Operating force	75 N (16.9 lbs)
Weight	16.5 kg (36.4 lbs)

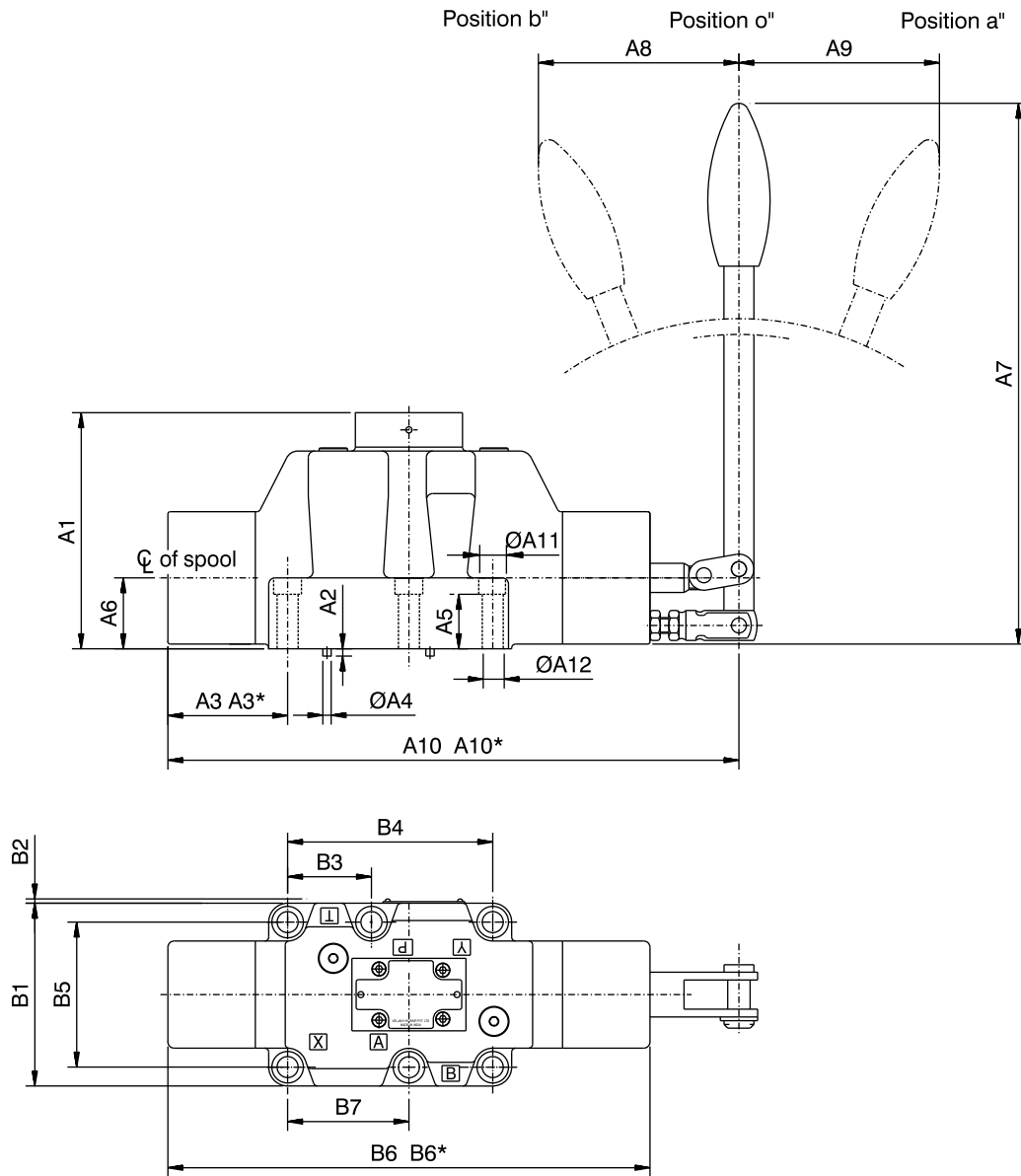

Note:
t44; Actuators are in principle at B-side for spool position 03.

Port Functions:

P	Pressure
T	Tank
A+B	User
X, Y	Pilot & Drain ports

* Dimensions for detent version.

Dimension	Dimension	
	inch	mm
A1	5.83	148
A2	0.26	6.6
A3	2.99	76
A3*	4.00	101.5
⌀A4	0.25	6.4
A5	1.73	44
A6	1.77	45
A7	13.39	340
A8	4.92	125
A9	4.92	125
A10	15.04	382
A10*	15.67	403
⌀A11	0.79	20
⌀A12	0.55	14

Dimension	Dimension	
	inch	mm
B1	4.57	116
B2	0.12	3
B3	2.09	53.2
B4	5.13	130.2
B5	3.63	92.1
B6	12.05	306
B6*	13.05	331.5
B7	3.03	77

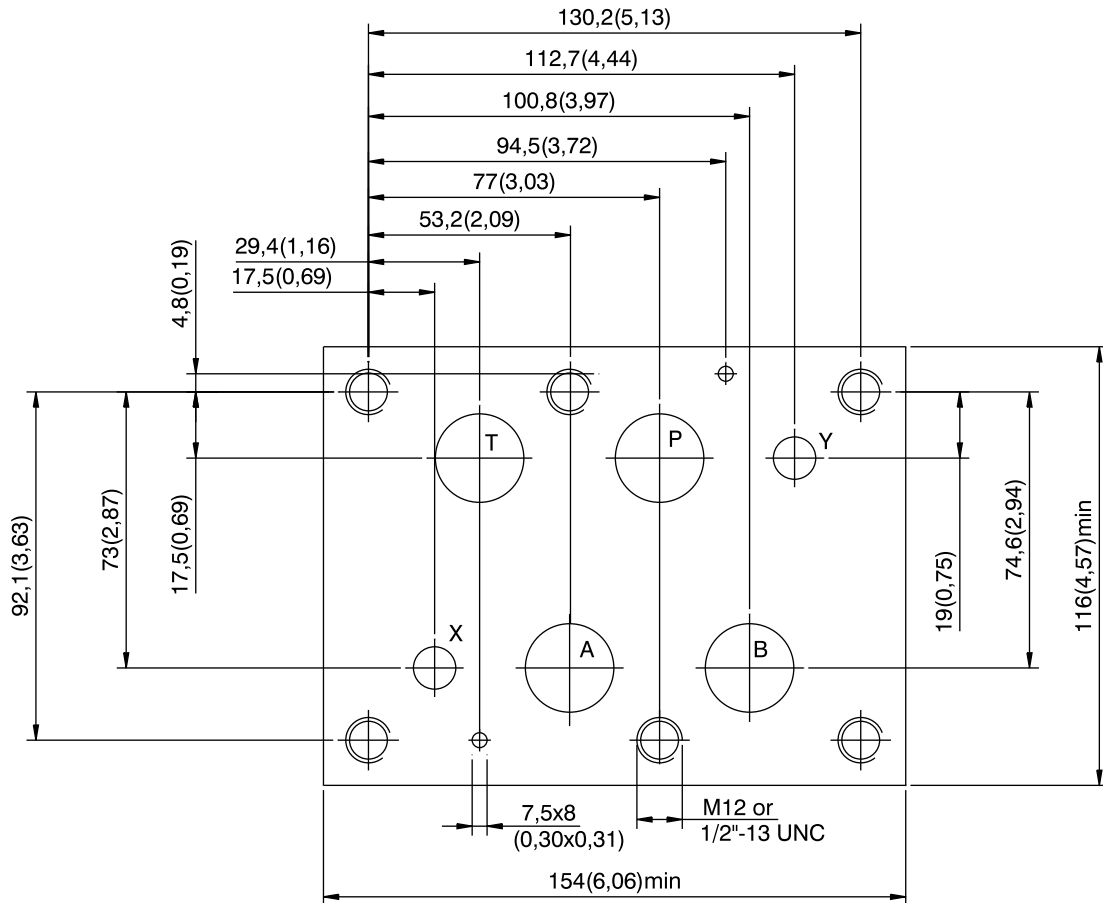

Valve Mounting Screws

Qty.	Mounting screws	Order-No.	Torque
6	M 12 x 65, DIN 912; 10.9	C-314001213	103 Nm (76 ft.lbs)
6	1/2"-13 UNC x 2 1/2 "(SAE)	358-20280	

NBR-Seals

A, B, T	28,17 x 3,53 mm	691-00216
P	31,34 x 3,53 mm	691-00218
X, Y	20,29 x 2,62 mm	691-00117

Block mounting face:-

Flatness 0.01 mm / 100 mm
(0,003/3,93 inches length)

Surface finish $\sqrt{0,8}$

Port Functions:

P	Pressure
T	Tank
A + B	Users
X valves.	Pilot port for external pilot operated valves
	Pilot port for hydr.operated
Y valves.	Drain port for external pilot operated valves
	Drain port for hydr.operated

Subplate (mounting configuration conforms to ISO 4401)

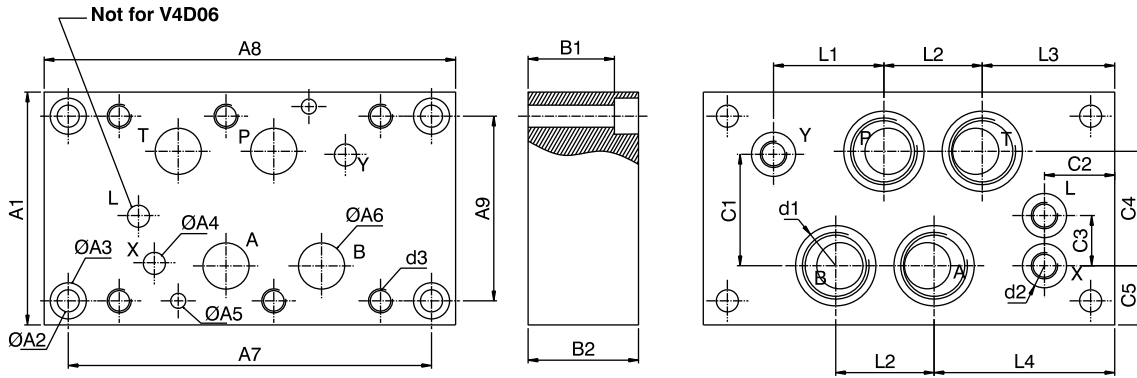

Weight = 8 kg (17.6 lbs)

Dimensions	Dimensions	
	in	mm
A1	4.6	116
ØA2	0.4	11
ØA3	0.7	18
ØA4	0.4	11
ØA5	0.3	7.5
ØA6	0.9	23
A7	7.1	181
A8	8.1	205
A9	3.6	92

Dimensions	Dimensions	
	in	mm
B1	1.7	43
B2	2.2	55

Dimensions	Dimensions	
	in	mm
C1	2.2	55.5
C2	1.4	35
C3	1.0	25
C4	2.3	57
C5	1.2	29.5

Model-No.	Order-No.	d1 (A, B, P, T)	d2 (X, Y, L)	d3	L1	L2	L3	L4
SS-B-12-G 130-L	S26-34487-0	G 3/4"	G 1/4"	M12 x26 dp	55	49	66	90
SS-B-16-G 130-L	S26-34480-0	G 1"	G 1/4"	M12 x26 dp	48.5	59.5	62	82

Panel opening

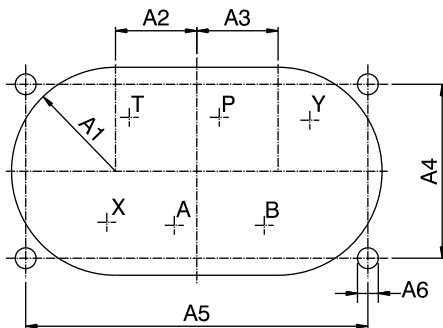

Dimensions	Dimensions	
	in	mm
A1	2.2	55
A2	1.7	43
A3	1.7	43
A4	3.6	92
A5	7.1	181
ØA6	0.4	11

Qty	Mounting screws	Order-No.	Torque
6	M 12 x 65, DIN 912; 10.9	C-314001213	103 N-m (76 ft-lb)