

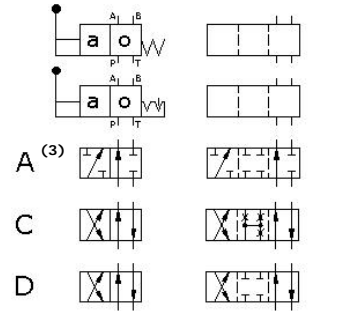

**Spool Types**

4/2 Way Valve with "o" and "a" positions



4/3 Way and 4/2<sup>(1)</sup> Way Valve

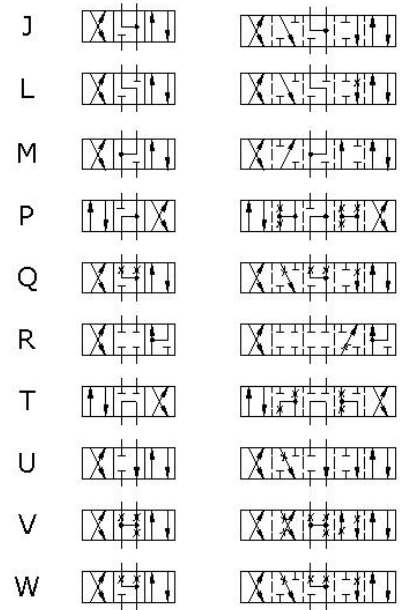
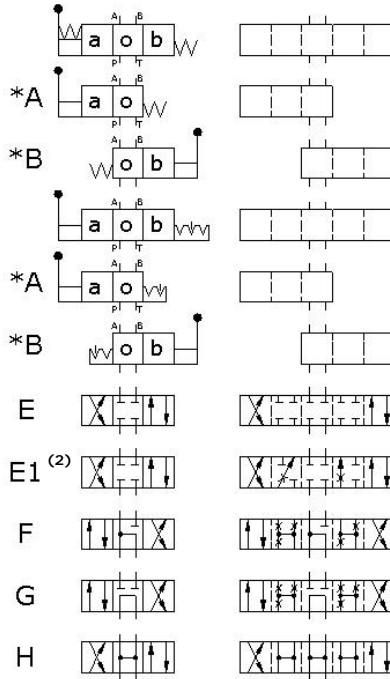

4/2 Way Valve with "o" and "b" positions

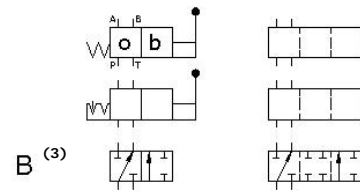

**Note:**

(1) When ordering a spool with only two positions "o" and "a" or "o" and "b", specify the desired position "A" or "B" in model code.

(2) Please check the possibility of cylinder intensification

(3) For spool type A and B. Port T must be used as drain line

Example: E Spool with "o" and "a" position—4DE10EA220A-01

**Characteristic Curves**

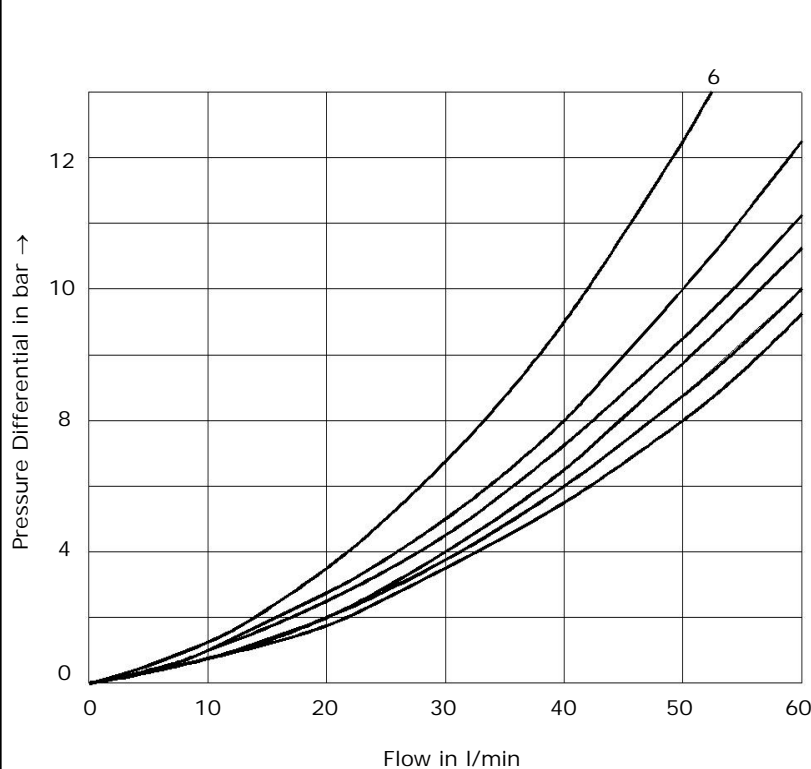

Spool Type	Direction of Flow				
	P→A	P→B	A→T	B→T	P→T
A	3	3	-	-	-
B	3	3	-	-	-
C	3	3	4	1	-
D	3	3	4	1	-
E	2	2	4	4	-
F	2	2	2	2	-
G	6	6	6	6	5
H	2	2	1	1	3
J	2	2	1	1	-
L	2	2	1	4	-
M	2	2	4	4	-
P	2	2	2	2	-

Pressure differential measured with ISO VG46 oil at 40°C ±10°C

Size 06

315 bar

60 lpm

**Ordering Code**

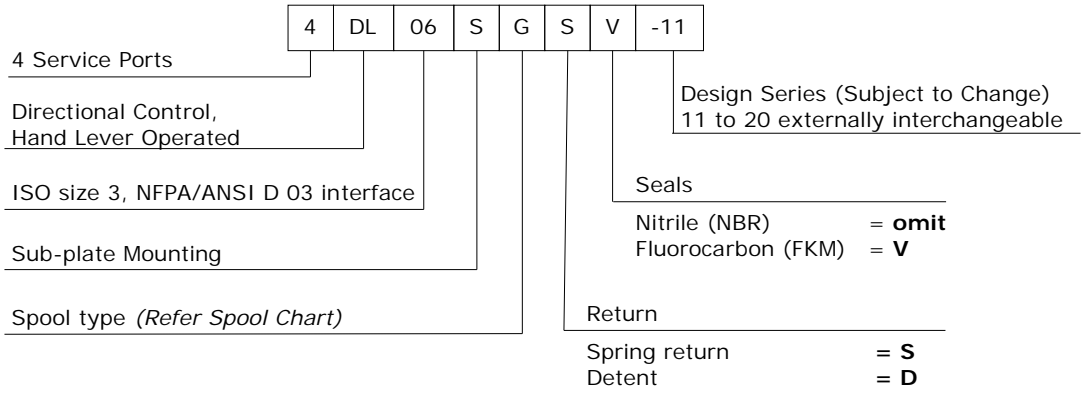

**Installation**

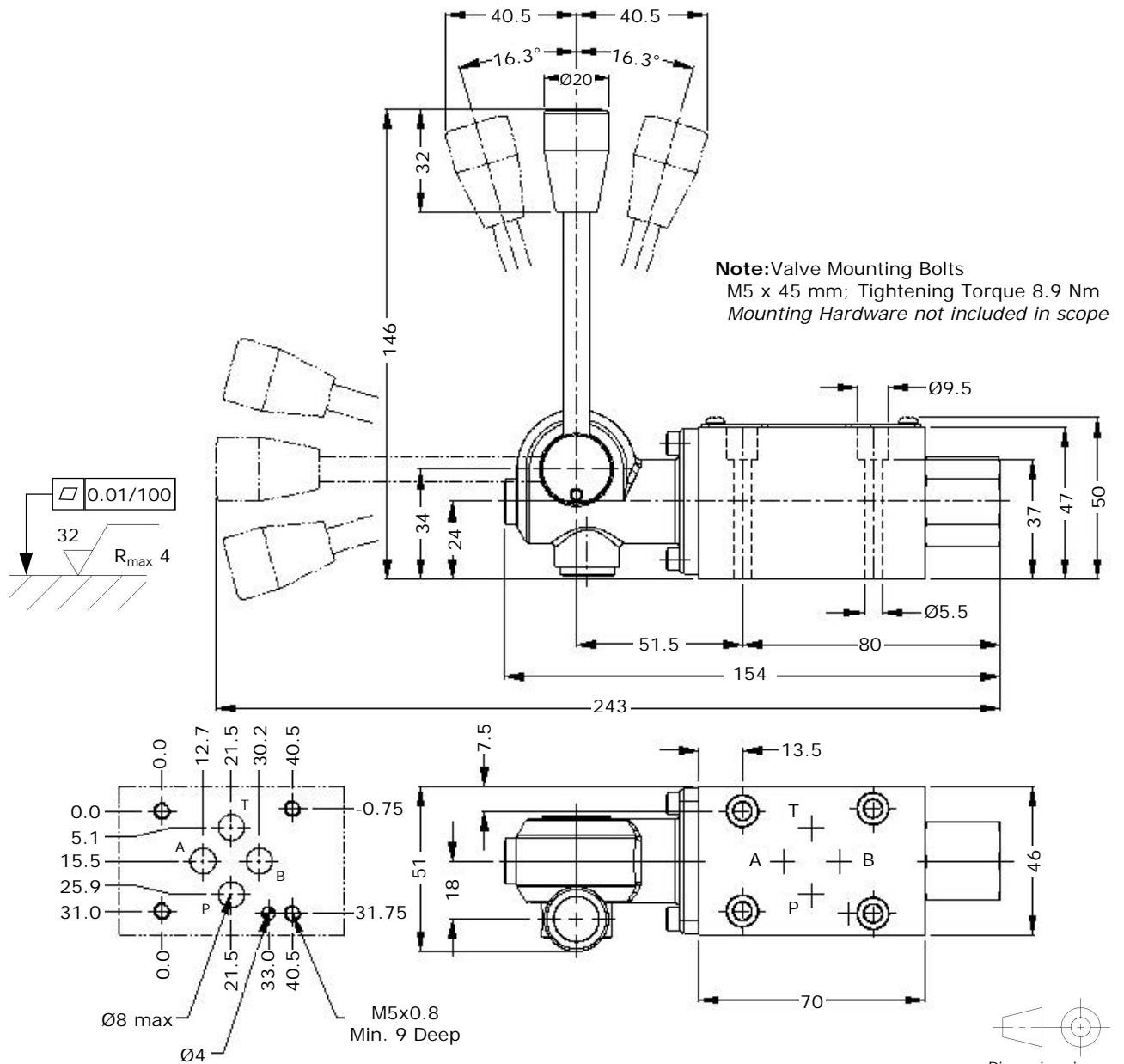



**Directional Control Valve  
With hand Lever Operation**

ENGINEERING

4/4

Size 06

315 bar

60 lpm

Y02501/09.03

**Notes**

Blank area for notes.